

Valves / Hydroblocks / HB-1539

CONSTRUCTIVE PROPERTIES

	STANDARD	OPTIONAL
Material	Ms-58 Brass (CuZn40Pb2)	-
Hydroblock Type	Monothermic	-
Domestic Hot Water Flow Rate (Inlet Block)	8 lt / min. 10 lt / min. 12 lt / min. 15 lt / min.	
Check Valve Opening Pressure (nominal)	Varies as per customer request	-
Safety Valve Opening Pressure (nominal)	3 bar	Varies as per customer request
Flow Sensor Type	Turbine (Hall Effect-Variable)	-
By-Pass Type	Internal - Through heat exchanger	-



HB-1539

USAGE PROPERTIES

Storage Temperature	-20 ... +60 °C	-
Max. Water Temp.	120°C	-

www.Laheghi.com

Valves / Hydroblocks / HB-1539

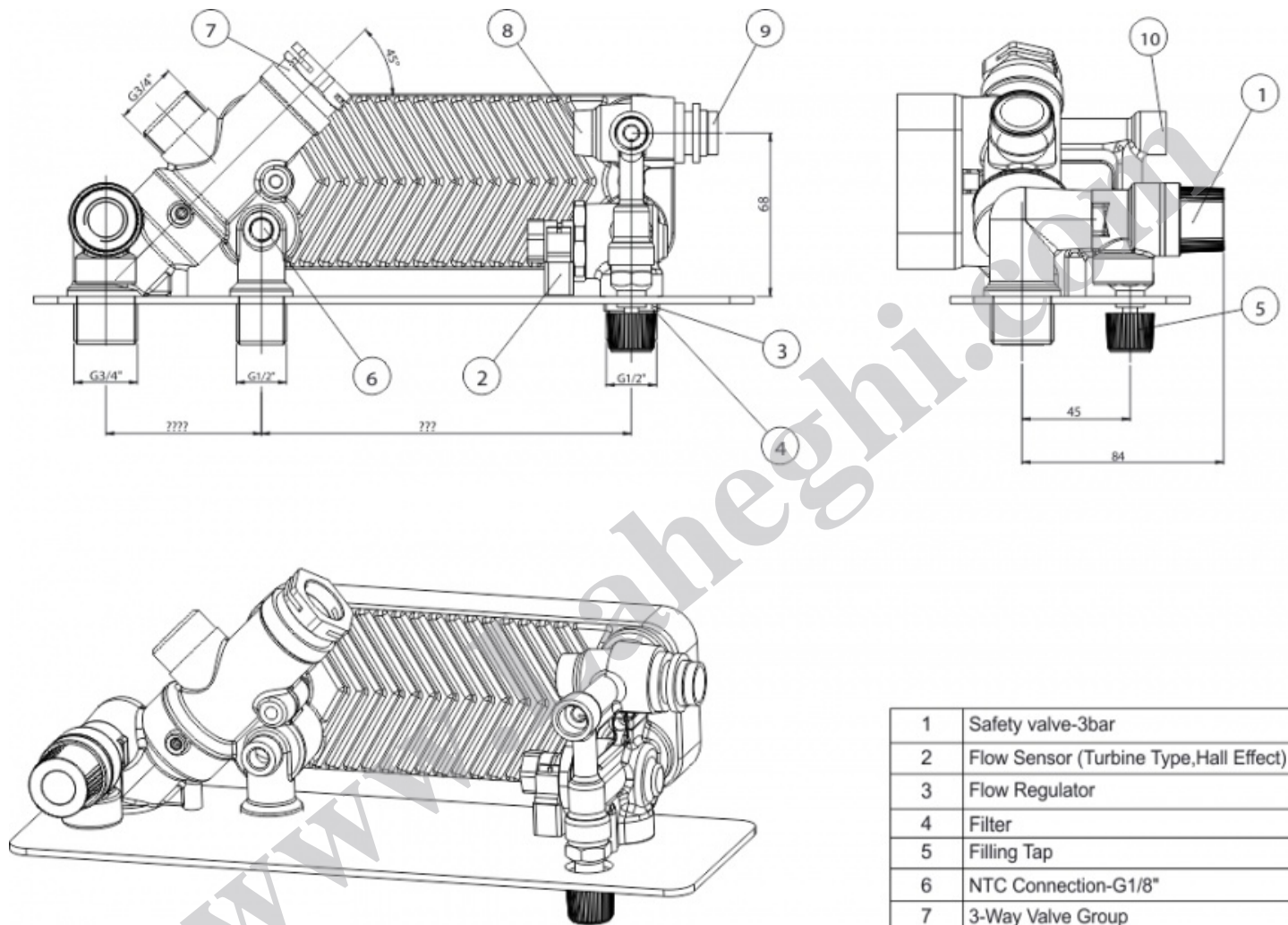

1	Safety valve-3bar
2	Flow Sensor (Turbine Type,Hall Effect)
3	Flow Regulator
4	Filter
5	Filling Tap
6	NTC Connection-G1/8"
7	3-Way Valve Group
8	High Pressure Connection- G1/4"
9	Pump Connection
10	Check Valve

Model No: HB-1539